

RMF Failure Mitigation Analysis

Vega Systems Inc.
2020
www.vega25.com

Two Site Redundancy

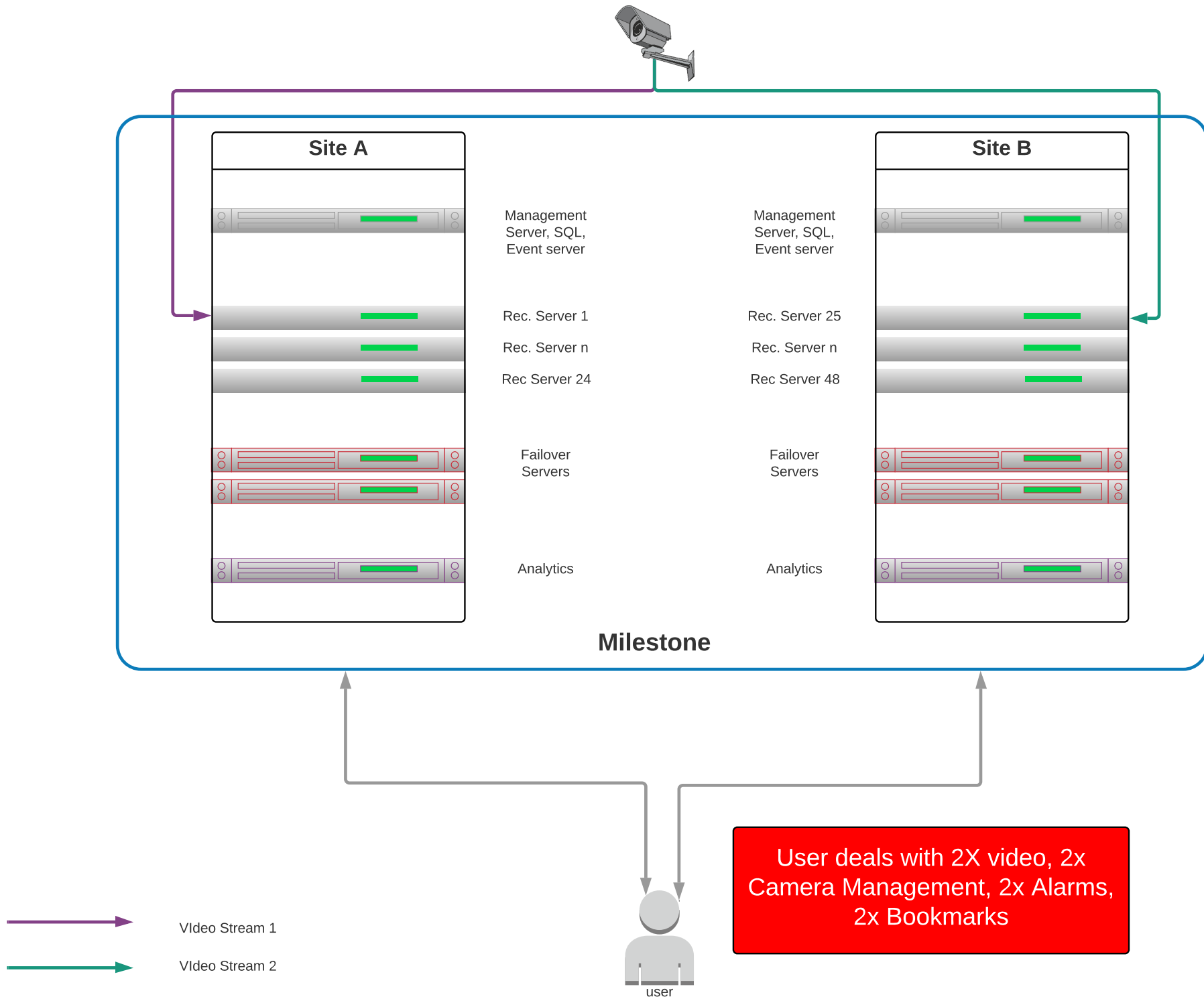

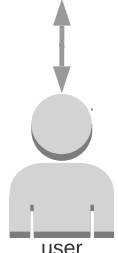
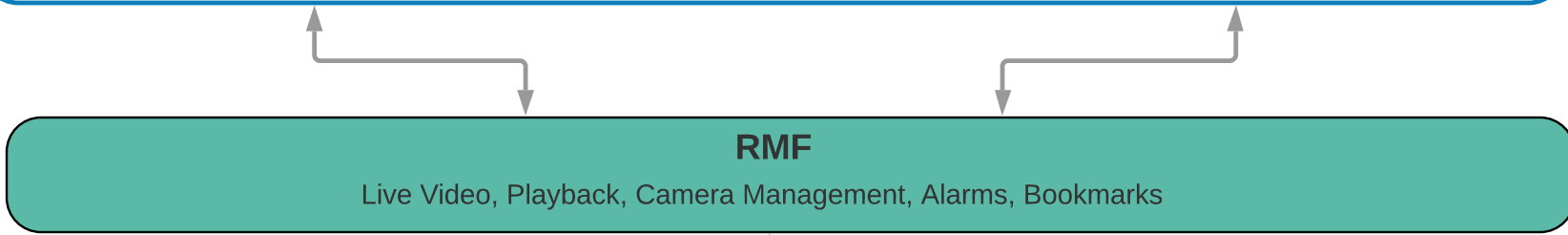
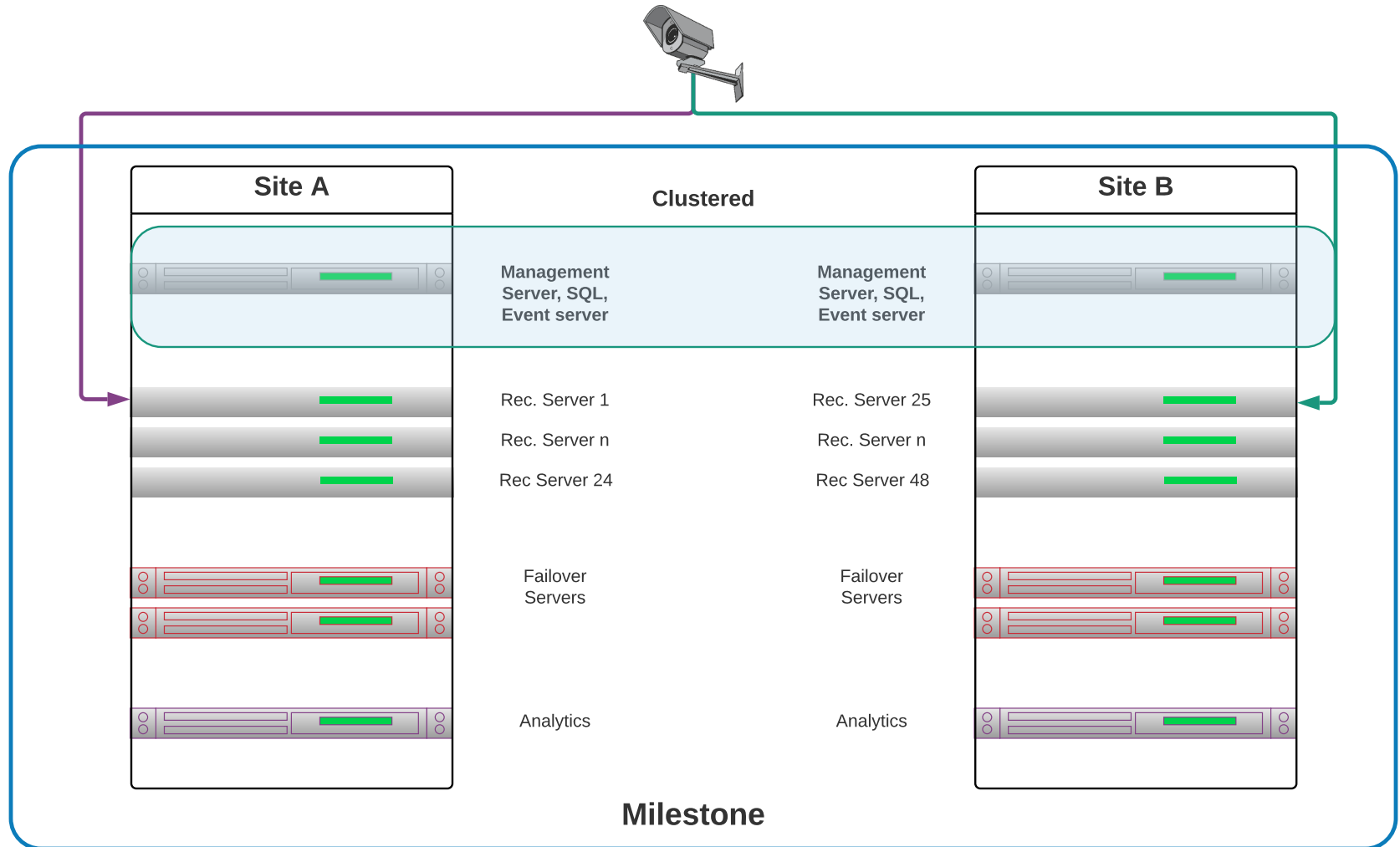

1 --> 2 from User to Milestone
2 --> 1 from Milestone to User

- Video Stream 1
- Video Stream 2

Recording Server Failure

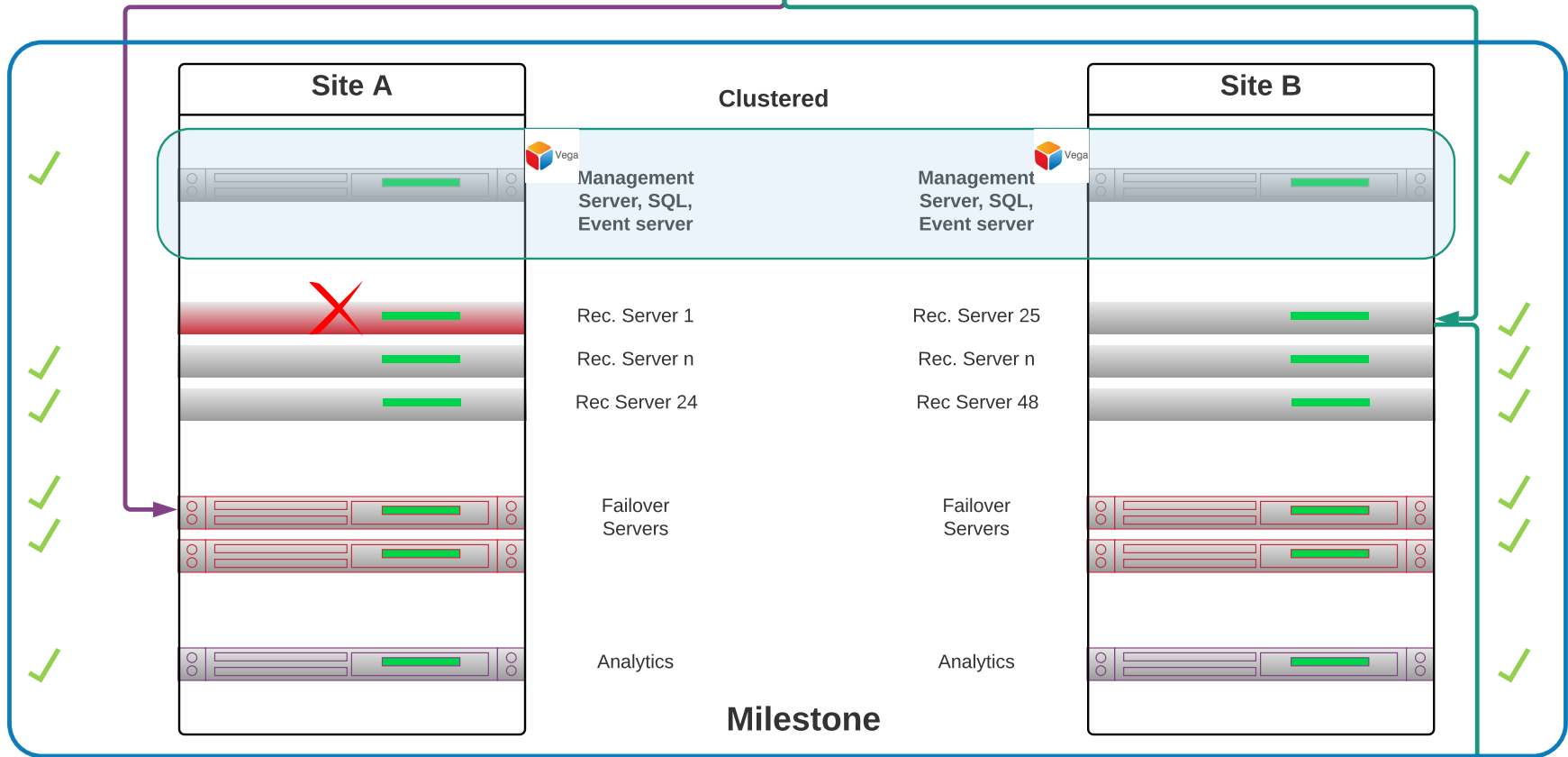
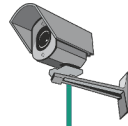

RMF
"Per stream" basis decision at "each" Smart Client



user



Video Stream 1



Video Stream 2

Management/SQL/Event Server Failure

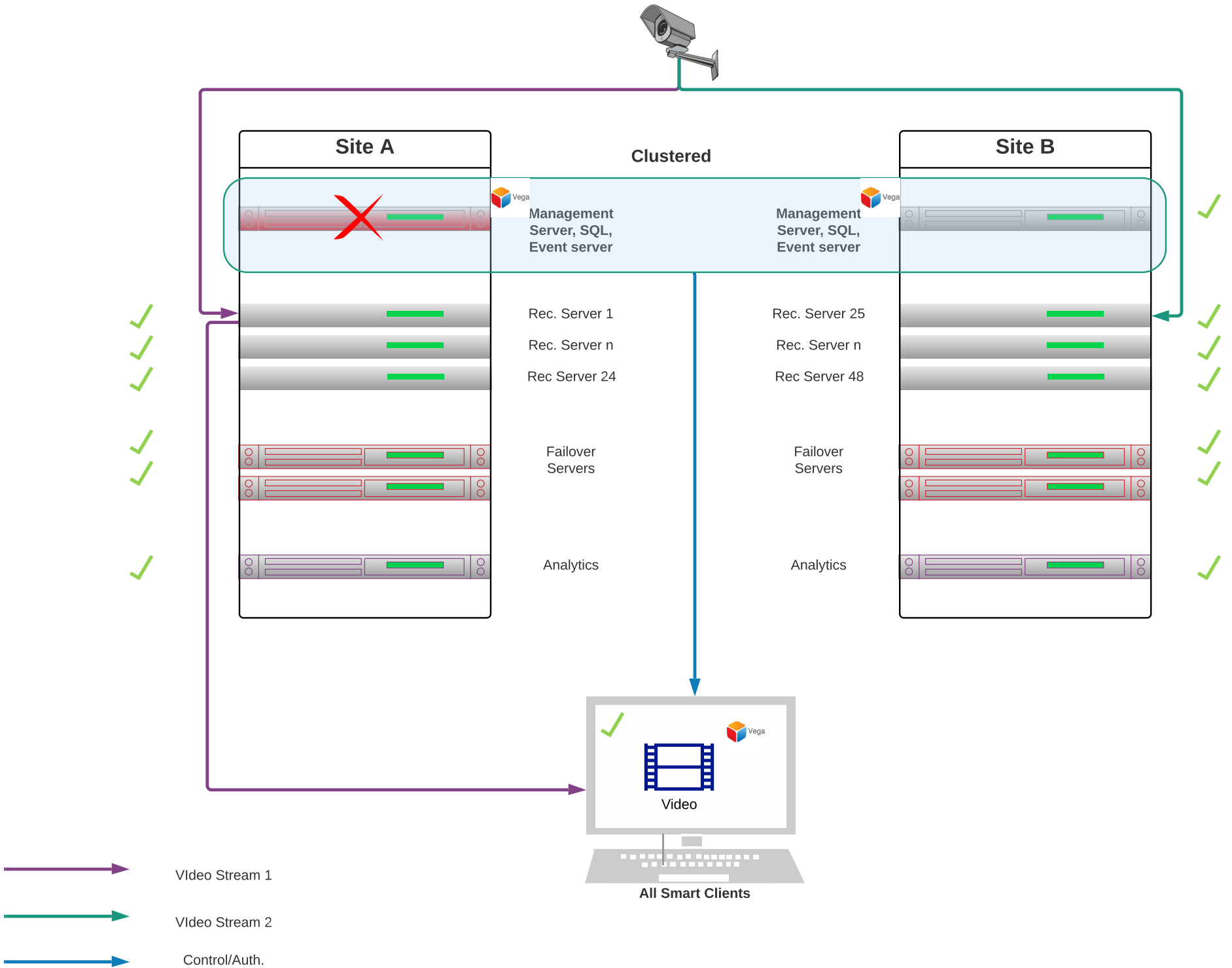

SITE FAILURE

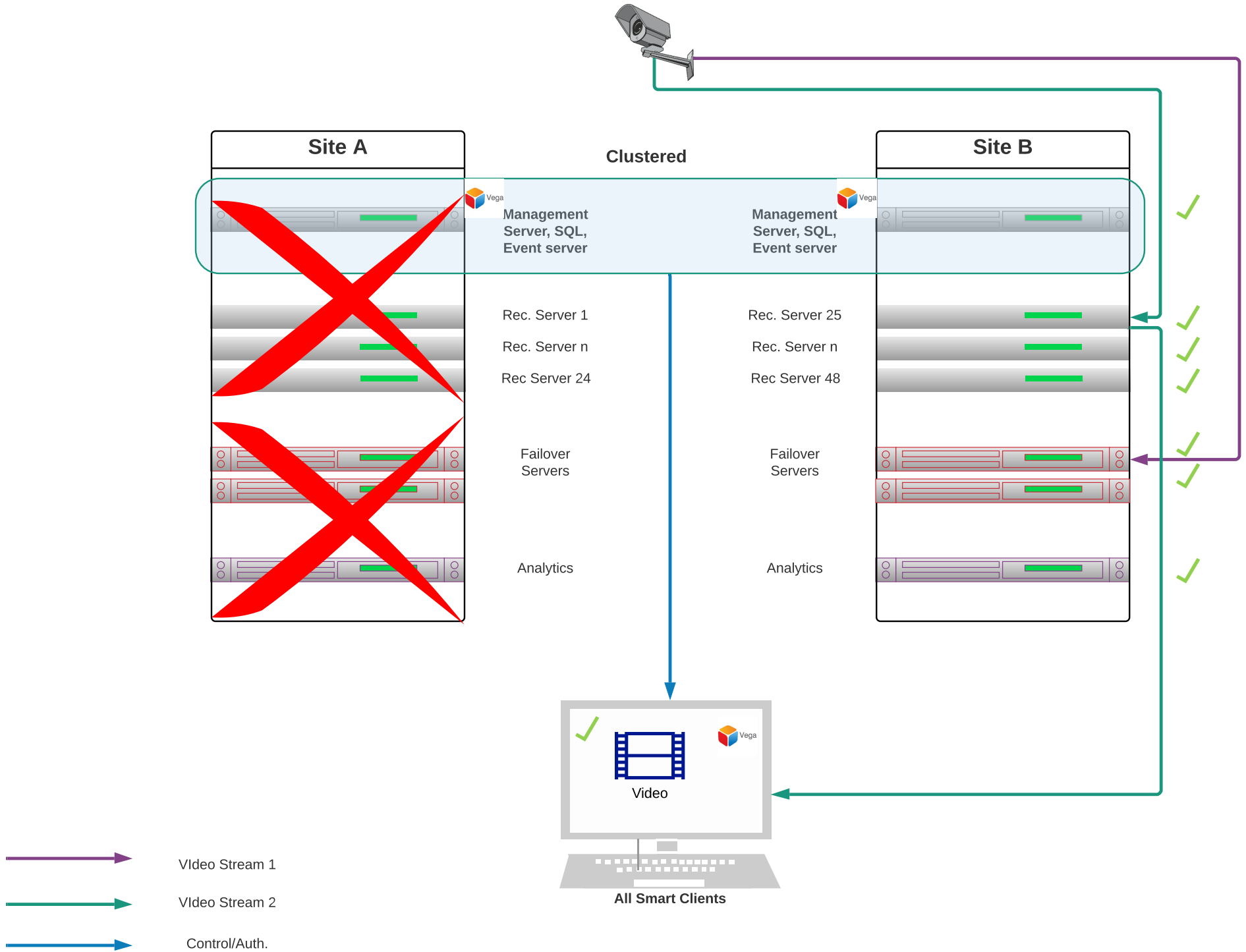

Camera Connection loss to one Site

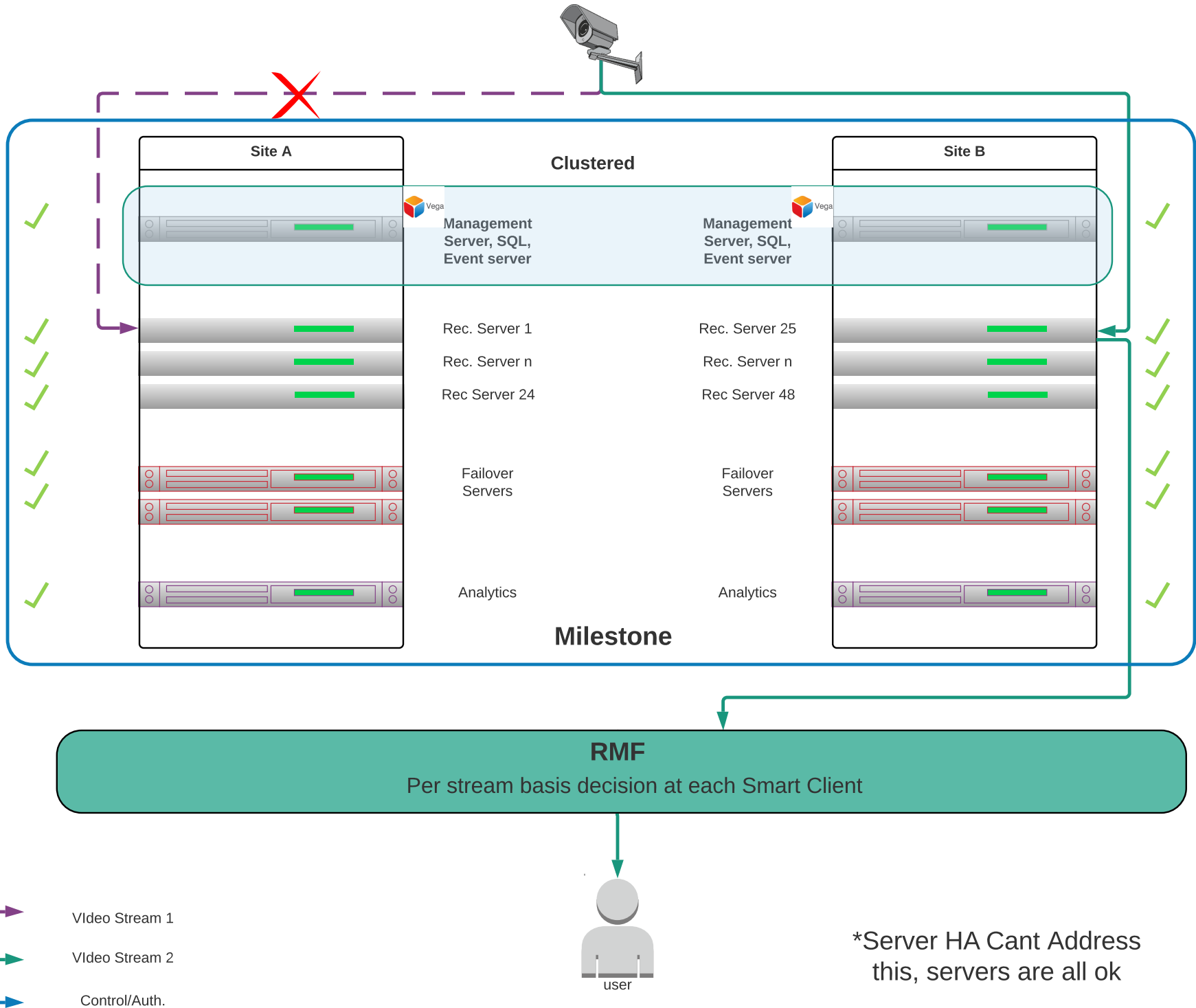

Server to Client Connection Loss

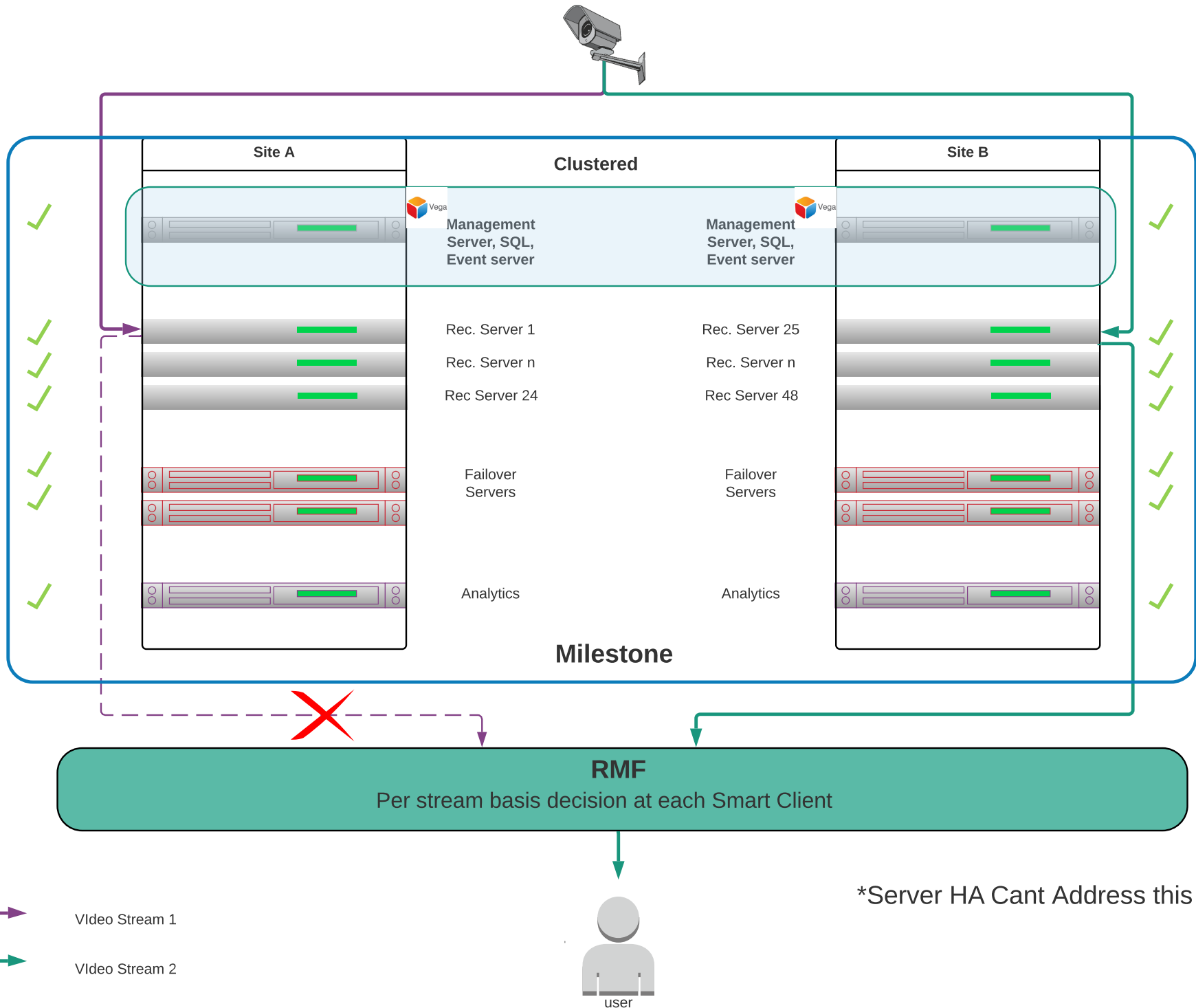

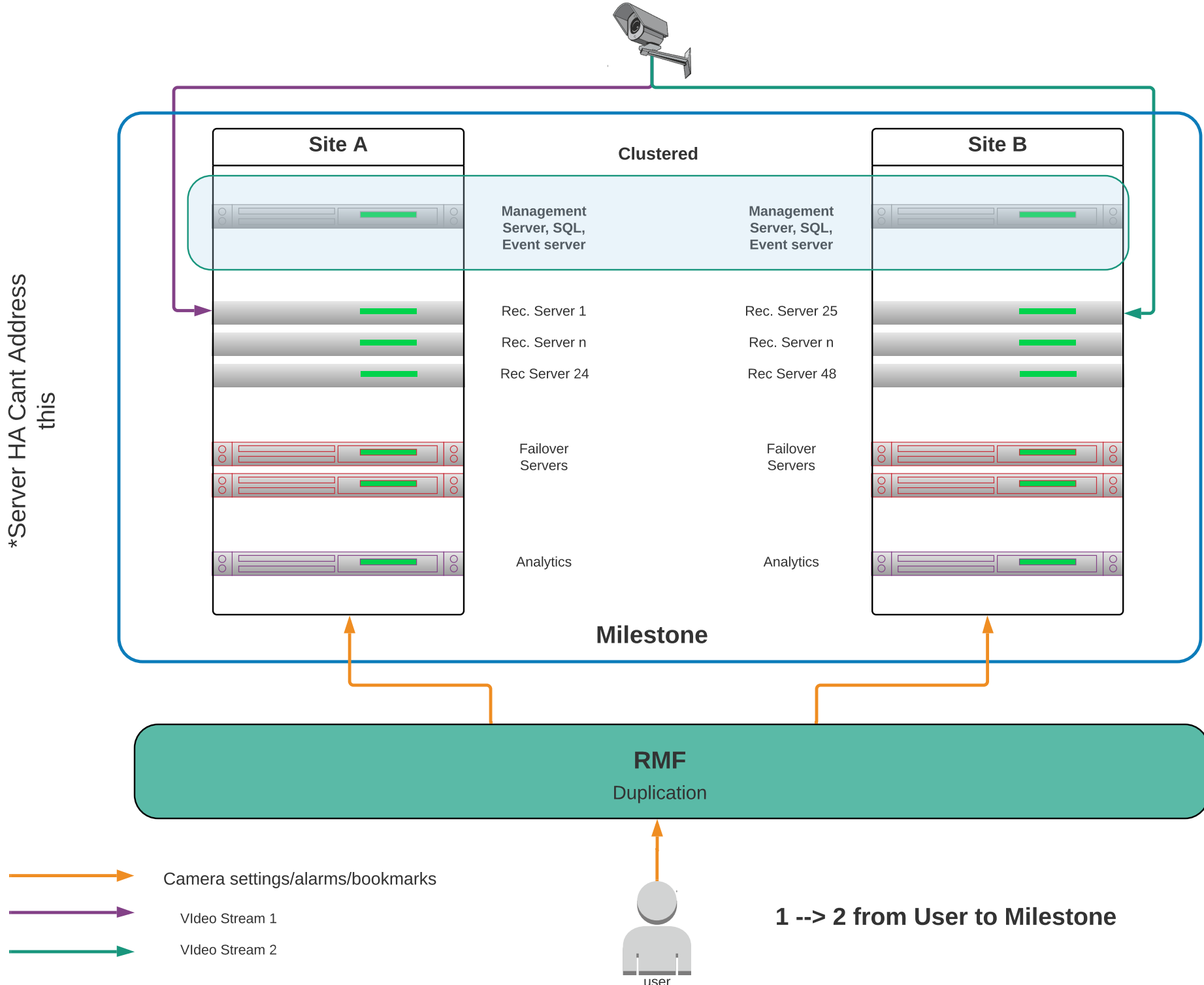

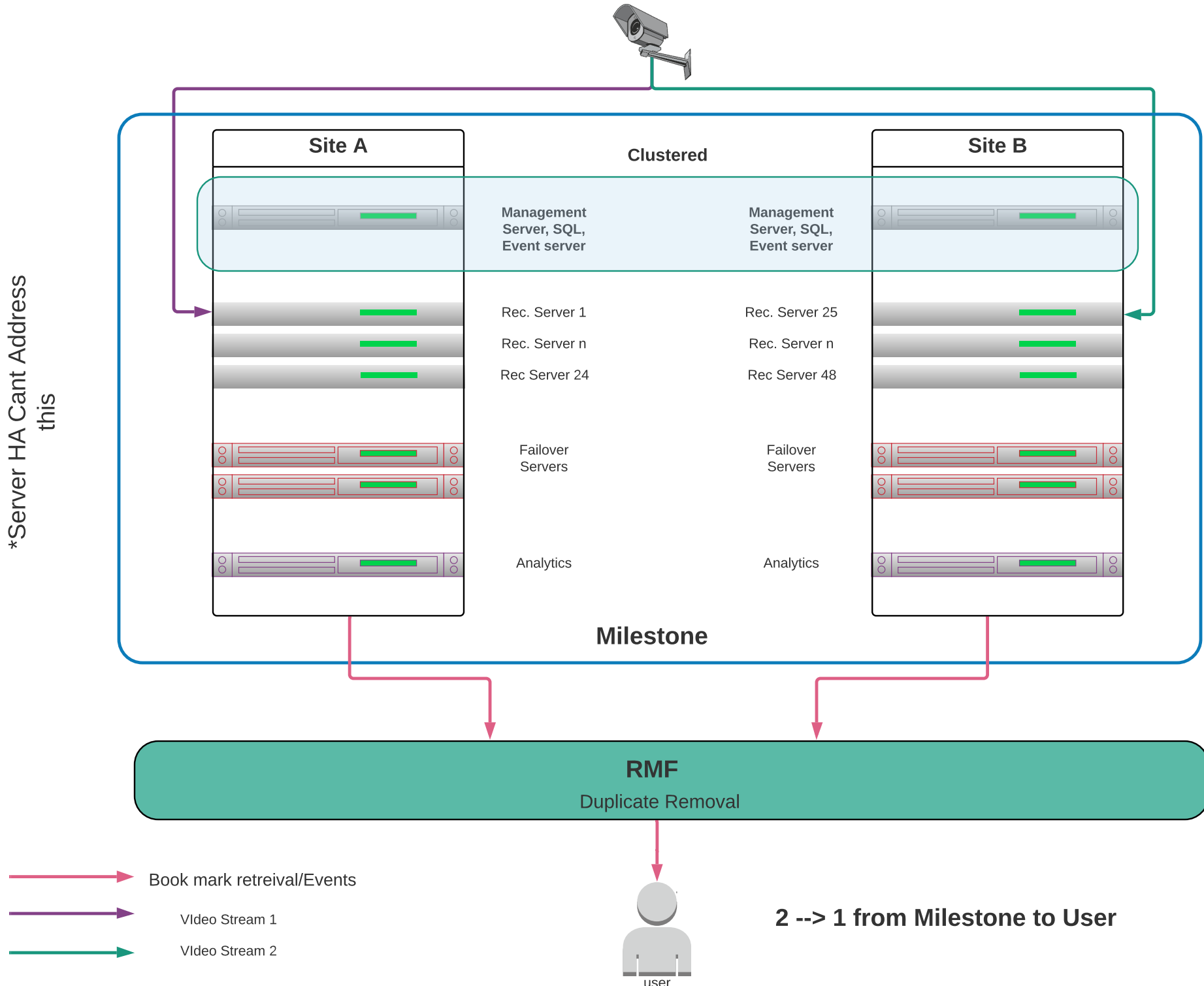

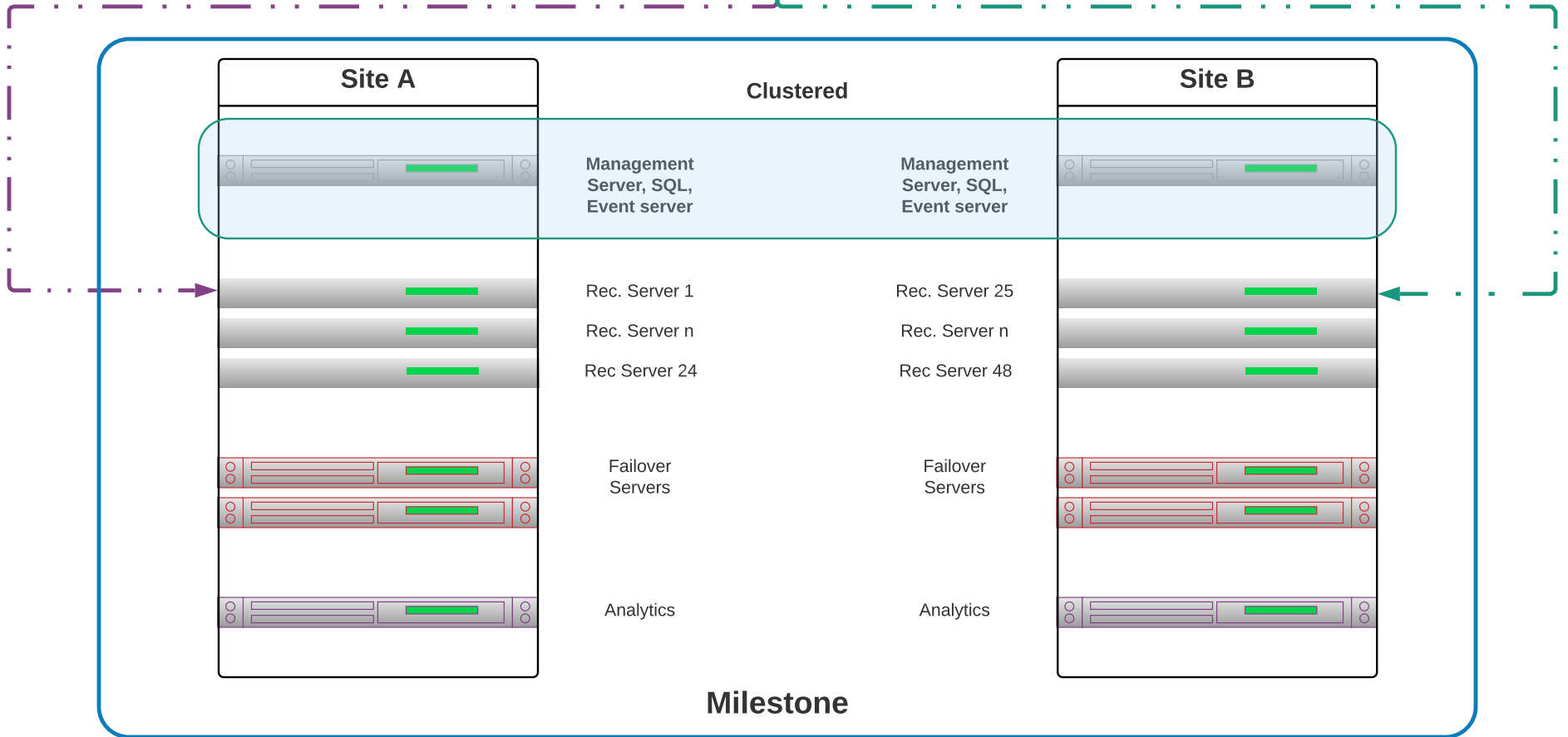
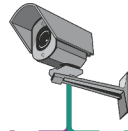

- - - - -> Missing Video Content Restoration Stream 1
- - - - -> Missing Video Content Restoration Stream 2

RMF vs. 'ANY' server level HA solution

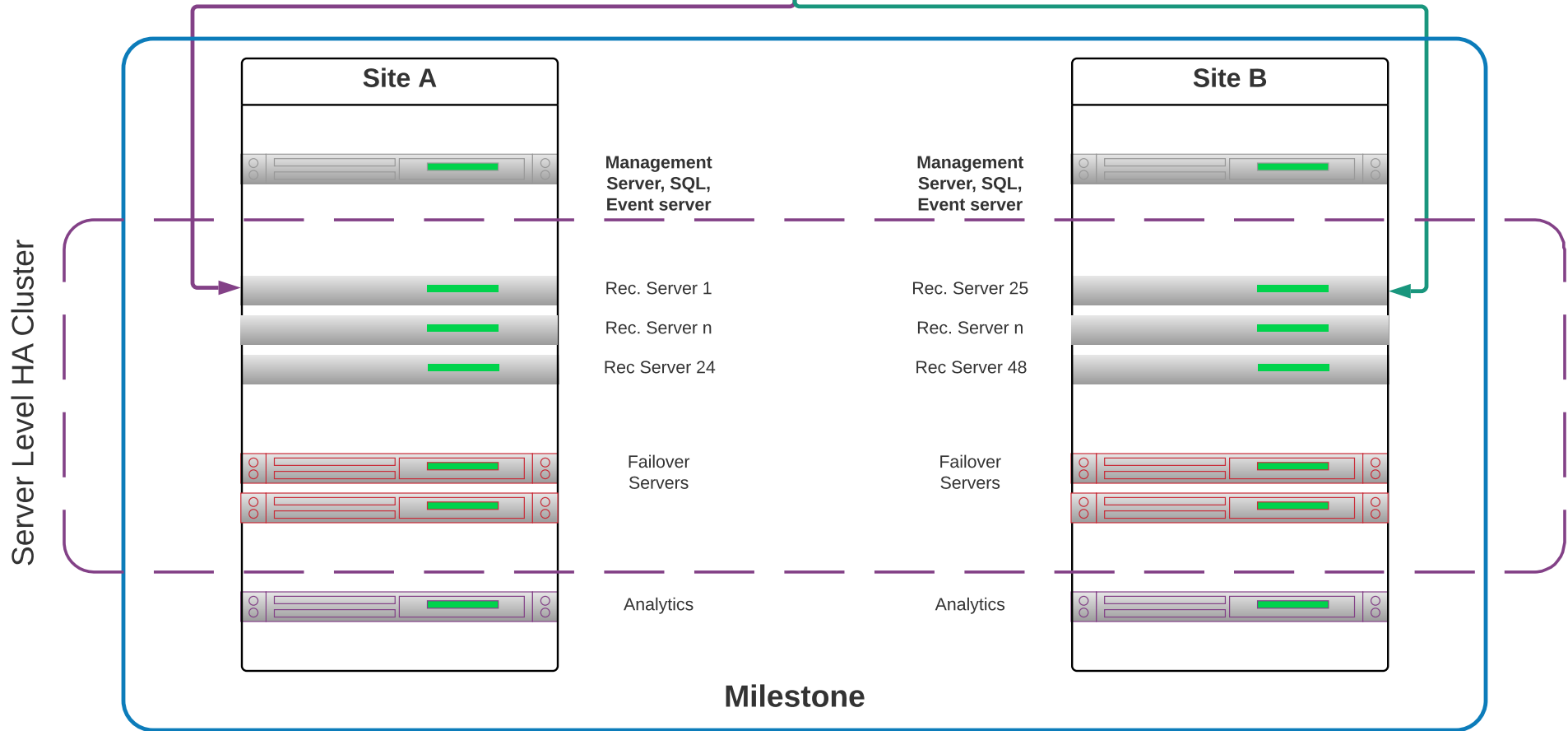
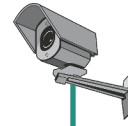

Server HA does not understand VMS operator use cases

User **STILL** deals with 2X video, 2x Camera Management, 2x Alarms, 2x Bookmarks

- Video Stream 1
- Video Stream 2





Contact



www.vega25.com



info@vega25.com



1999 S Bascom Ave #700,
Campbell, CA 95008